

DVR Based Voltage Sag Compensation in Multi-Bus System with AC-AC Converter Topology

M.Vimalraj¹, M. Riyas Ahamed², R. Arun Prasath³

¹Assistant Professor/EEE, TPEVRPC, Tamil Nadu, India.

²Assistant Professor/EEE, C. Abdul Hakeem College of Engineering & Technology, Tamil Nadu, India

³Assistant Professor/EEE, Ranipettai Engineering College, Tamil Nadu, India.

Corresponding Author: M. Vimalraj

Received: 16/05/2015

Revised: 09/06/2015

Accepted: 12/06/2015

ABSTRACT

Conventional topologies operate with a dc link, which makes them bulkier and costlier; it also imposes limits on the compensation capability of the DVR. The dynamic voltage restorer (DVR) is a definitive solution to address the voltage-related PQ problems. This paper presents the voltage sag compensation in multi-bus system with ac chopper based dynamic voltage restorer, Voltage sag remains a serious power-quality (PQ) problem by being the most common and causing more economic losses. Topologies with the same functionality, operating without the dc link by utilizing a direct AC-AC converter, are preferable over the conventional ones. Since no storage device is employed, these topologies require improved information on instantaneous voltages at the point of common coupling and need flexible control schemes depending on these voltages. Therefore, a control scheme for DVR topologies with an AC-AC converter, based on the characterization of voltage sags is proposed to mitigate voltage sags with phase jump. The proposed control scheme is tested on an inter-phase AC-AC converter topology to validate its efficacy by using MATLAB.

Index Terms: Voltage sag compensation, Multi-bus system, Power quality, DVR, AC-AC converter

I. INTRODUCTION

Nowadays, modern industrial devices are mostly based on electronic devices such as programmable logic controllers and electronic drives. The electronic devices are very sensitive to disturbances and become less tolerant to power quality problems such as voltage sags, swells and harmonics. Voltage dips are considered to be one of the most severe disturbances to the industrial equipment. Voltage support at a load can be achieved by reactive power injection at the load point of

common coupling. The common method for this is to install mechanically switched shunt capacitors in the primary terminal of the distribution transformer. The mechanical switching may be on a schedule, via signals from a supervisory control and data acquisition (SCADA) system, with some timing schedule, or with no switching at all. The disadvantage is that, high speed transients cannot be compensated. Some sags are not corrected within the limited time frame of mechanical switching devices. Transformer taps may be used, but tap

changing under load is costly. Another power electronic solution to the voltage regulation is the use of a dynamic voltage restorer (DVR). DVRs are a class of custom power devices for providing reliable distribution power quality. They employ a series of voltage boost technology using solid state switches for compensating voltage sags/swells. The DVR applications are mainly for sensitive loads that may be drastically affected by fluctuations in system voltage.

A dynamic voltage restorer (DVR) is a series-connected custom power device to mitigate voltage sags. The injected voltage is generated either by a voltage-source inverter supported by energy storage or conventionally by an ac–dc–ac converter or by a direct converter eliminating the dc link. Energy storage makes the DVR unit bulkier and costlier. Also, the dc link imposes a limit on compensation capability of the DVR in terms of magnitude and duration of compensation. Besides these shortcomings, the dc link is redundant in a system where there is no significant frequency change. Therefore, the topologies that eliminate the dc link and yet retain the same functionalities are potential alternatives. The matrix converter has especially found applications in the DVR topologies, a combination of a matrix converter and a flywheel, for energy storage, is employed to mitigate sag with bidirectional power flow, but the presence of the flywheel again limits the compensation capability. Vector switching converters (VeSCs) based on matrix switching are used to inject the missing positive- and negative-sequence components to compensate for balanced and unbalanced voltage sags.

The objective of the project is to new method has been suggested for the dynamic voltage restorer (DVR) is a definitive solution to address the voltage-related PQ problems. Conventional topologies operate

with a dc link, which makes them bulkier and costlier; it also imposes limits on the compensation capability of the DVR. Topologies with the same functionality, operating without the dc link by utilizing a direct ac–ac converter, are preferable over the conventional ones. Since no storage device is employed, these topologies require improved information on instantaneous voltages at the point of common coupling and need flexible control schemes depending on these voltages. Therefore, a control scheme for DVR topologies with an ac–ac converter, based on the characterization of voltage sags is proposed in this project to mitigate voltage sags with phase jump. The proposed control scheme is tested on an inter-phase ac–ac converter topology to validate its efficacy.

II. DVR BASED VOLTAGE COMPENSATION

The influx of digital electronics for computing and control applications has made quality power an inevitable requirement. A major data centre reports that a 2-s interruption can cost. Since voltage sag can occur even due to a remote fault in a system, it is more often than an interruption and can occur 20–30 times per year each in an industry. Therefore, voltage sag is a serious power-quality (PQ) problem to be addressed. Voltage sag refers to a momentary decrease (0.5 to 1 min) in rms voltage between 0.1 and 0.9 p.u. at the power frequency. A model of voltage sag at the point of common coupling (PCC) is illustrated.

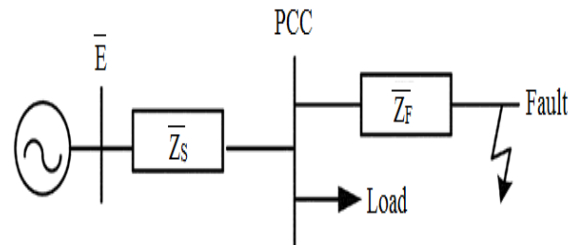

Fig.1 Single-phase model for voltage sag at the PCC.

A dynamic voltage restorer (DVR) is a series-connected custom power device to mitigate voltage sags. Single-phase model for voltage sag at the PCC. Voltage is generated either by a voltage-source inverter supported by energy storage or conventionally by an ac–dc–ac converter or by a direct converter eliminating the dc link. Energy storage makes the DVR unit bulkier and costlier. Also, the dc link imposes a limit on compensation capability of the DVR in terms of magnitude and duration of compensation. It is calculated that the converter rating for the DVR to compensate a load of 1.0 p.u. during 0.5-p.u. voltage sag is at least 2.0p.u. Besides these shortcomings, the dc link is redundant in a system where there is no significant frequency change. Therefore, the topologies that eliminate the dc link and yet retain the same functionalities are potential alternatives. Preliminary research on the new family of DVRs that eliminates the dc link dates back to 1996. Only sparse developments in the topology are reported in the literature, until advancements in semiconductor technology. The development of bidirectional switches, in turn, augmented the growth of a new array of ac–ac converters, such as matrix converters and Z-source converters. The matrix converter has especially found applications in the DVR topologies. A combination of a matrix converter and a flywheel, for energy storage, is employed to mitigate sag with bidirectional power flow, but the presence of the flywheel again limits the compensation capability. Vector switching converters (VeSCs), based on matrix switching, and are used to inject the missing positive- and negative-sequence components to compensate for balanced and unbalanced voltage sags. Though the control looks simple, it involves 10 transformers and 18 bidirectional switches. Some other interesting applications based on the matrix

converter suggest a novel idea of cross-phase voltage injection, since drawing more power from the affected phase further weakens it.

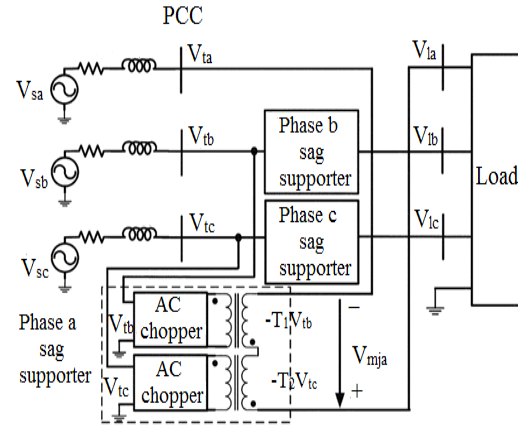

Fig.2 The interphase ac–ac converter topology

Has a sag supporter in each phase consisting of two choppers connected to the other two phases independently, and it can account for phase-jump compensation.

However, the development in the DVR topologies, with direct converters, is not matched with that of the control algorithms. Most of them are controlled either by instantaneous comparison of the voltage at the PCC with a unit reference vector or simple. Interphase ac–ac converter topology. Feed forward control to adjust the duty cycle. Since these topologies eliminate the dc link, the compensation depends directly on the voltage at the PCC, and each type of unbalance in the voltage at PCC imposes a limit on the compensation capability distinctly. Therefore, in this project, a control scheme based on characterization of voltage sag is proposed for the topologies.

III. SIMULATION RESULTS AND DISCUSSION

Fig.3 shows the simulation which describes line model without any

compensation hence experience voltage sag at time 0.2 sec when both loads are added.

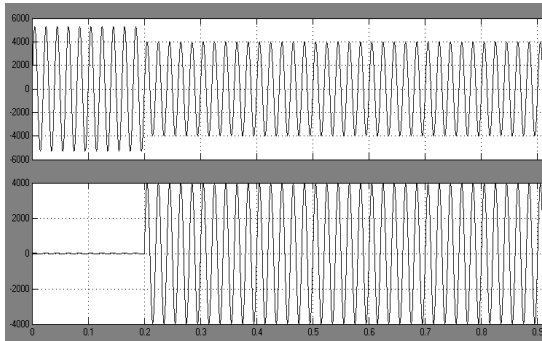

Fig 3 Voltage across LOAD -1 AND LOAD-2

The Fig.4 shows simple line compensation with AC source. DVR shows better compensation than AC source as discussed below. The AC source is added only after time interval 0.2 sec.

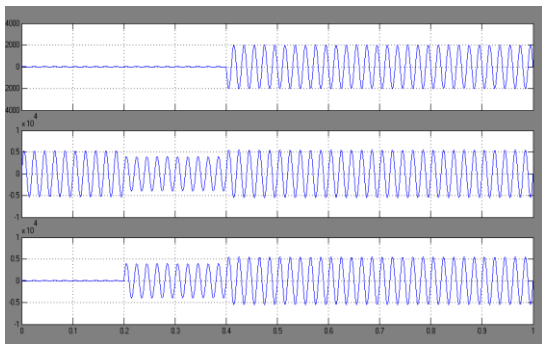

Fig.4 Voltage across transformer primary in external source, LOAD -1 and LOAD-2

DVR circuit without LC filter gives square wave output and compensation starts from time 0.4 sec as the breaker in DVR turns on at time 0.4 sec is shown in Fig.5.



Fig.5 Voltage across external, LOAD-1 &LOAD-2 waveforms

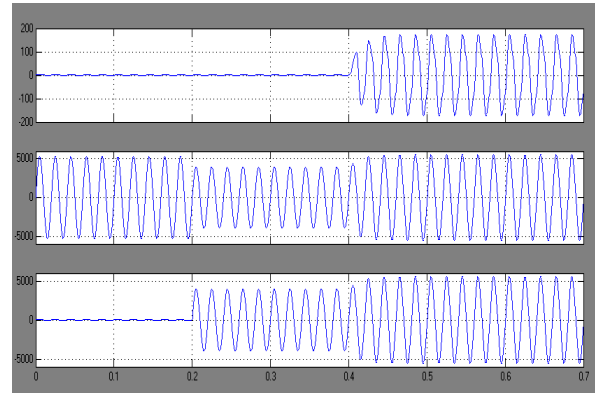

Fig .6 Voltage across external, LOAD-1 &LOAD-2 waveforms

(i) 14 Bus System Without DVR

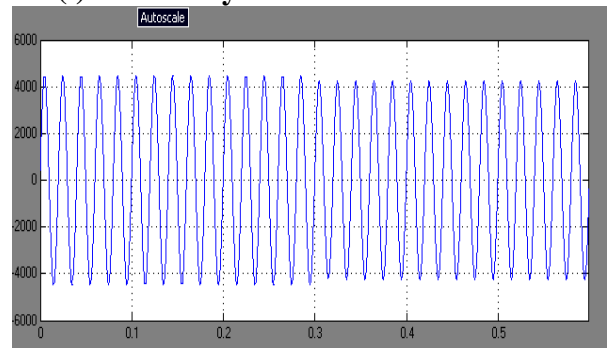

Fig.7 Voltage across bus-3

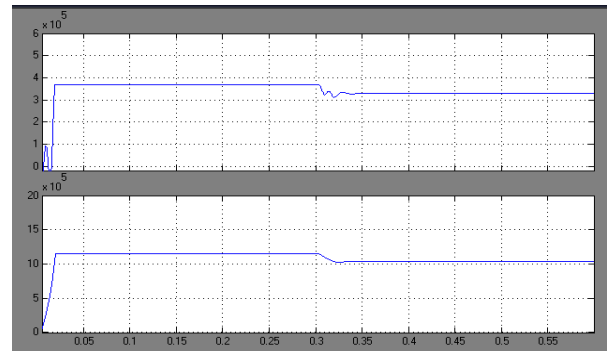

Fig.8 Real and Reactive Power across Bus-3

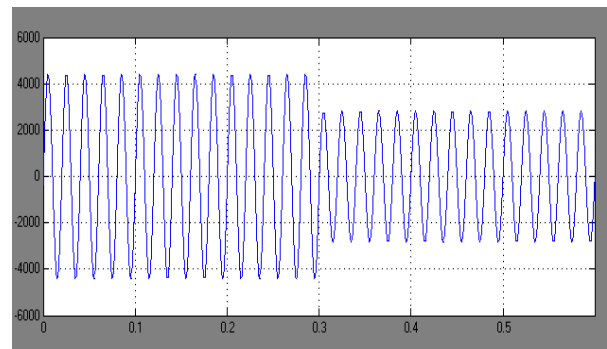

Fig.9 Voltage across bus-11

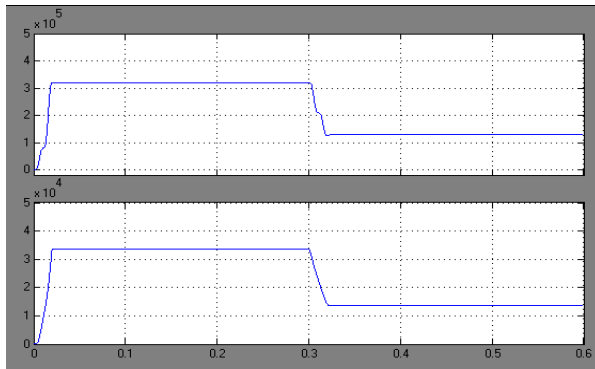

Fig.10 Real and Reactive Power across Bus 11

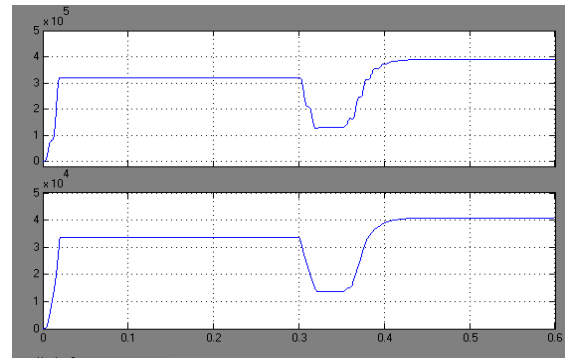

Fig.14 Real and Reactive Power across Bus-11

(ii) 14 Bus System With DVR

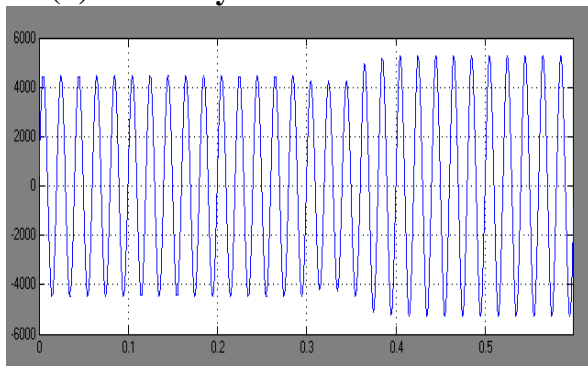

Fig.11 Voltage across bus-3

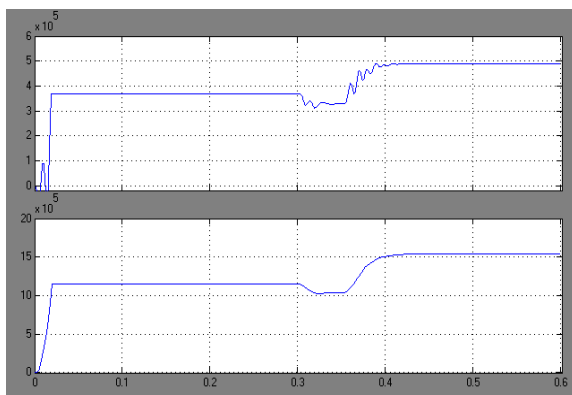

Fig.12 Real and Reactive Power across Bus-3

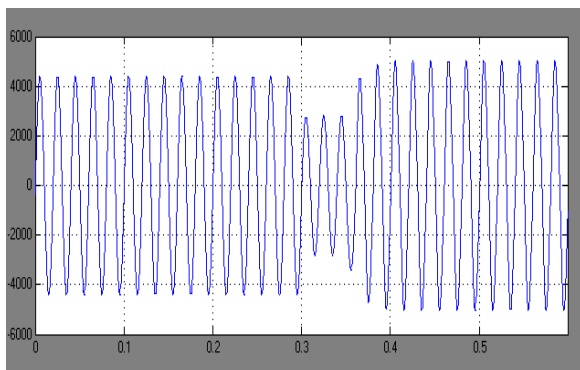

Fig.13 Voltage across bus-11

Table-1. Real and reactive power comparison

| Bus no. | Real Power Without DVR (MW) | Real Power With DVR (MW) | Reactive Power Without DVR (MVAR) | Reactive Power With DVR (MVAR) |
|---------|-----------------------------|--------------------------|-----------------------------------|--------------------------------|
| BUS-7 | 0.214 | 0.306 | 0.242 | 0.558 |
| BUS-1 | 0.247 | 0.2337 | 0.258 | 0.245 |
| BUS-3 | 0.328 | 0.491 | 1.033 | 1.542 |
| BUS-11 | 0.13 | 0.39 | 0.0136 | 0.41 |

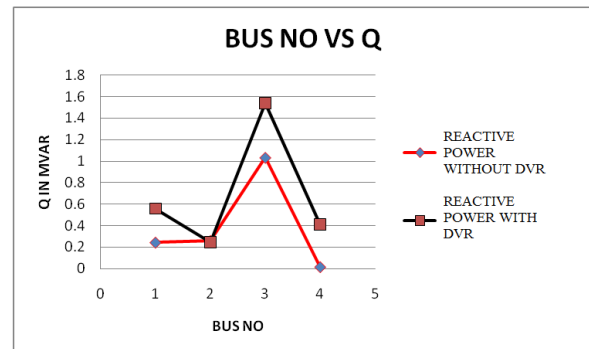

Fig.15 Comparison between with & without DVR based on reactive power

IV. CONCLUSION

This paper has presented the procedures for a control scheme based on the characterization of voltage sag is proposed. It is tested on interphase AC-AC converter topology and it is found that the scheme besides compensation gives insight on the limits on compensation imposed by various sag types. Therefore, it aids in the flexible compensation by switching between pre-sag and in-phase compensation. The scheme provides 100% compensation for type sag, and for all other types, compensation up to 50% sag magnitude with phase jumps ranging from 60 to 60 for

interphase AC–AC topology. The algorithm takes, at most, half a cycle to compensate and it works in the presence of harmonics and unbalance, since the Fourier transform is employed to extract the fundamental component.

V. REFERENCES

- R. S. Vedam and M. S. Sarma, *Power Quality: VAR Compensation in Power Systems*. Boca Raton, FL, USA: CRC, 2009.
- M. H. J. Bollen, *Understanding Power Quality Problems*. Piscataway, NJ, USA: IEEE, 2000.
- R. C. Dugan, M. F. McGranaghan, S. Santoso, and H.W. Beaty, *Electrical Power Systems Quality*. New York, USA: McGraw-Hill, 2004.
- J. G. Nielsen and F. Blaabjerg, “A detailed comparison of system topologies for dynamic voltage restorers,” *IEEE Trans. Ind. Appl.*, vol. 41, no. 5, pp. 1272–1280, Sep./Oct. 2005.
- G. Venkataramanan, B. K. Johnson, and A. Sundaram, “An AC-AC power converter for custom power applications,” *IEEE Trans. Power Del.*, vol. 11, no. 3, pp. 1666–1671, Jul. 1996.
- S. M. Hietpas and M. Naden, “Automatic voltage regulator using an AC voltage-voltage converter,” *IEEE Trans. Ind. Appl.*, vol. 36, no. 1, pp. 33–38, Jan./Feb. 2000.
- E. C. Aeloíza, P. N. Enjeti, L. A. Morán, O. C. M. Hernandez, and
- S. Kim, “Analysis and design of a new voltage sag compensator for critical loads in electrical power distribution systems,” *IEEE Trans. Ind. Appl.*, vol. 39, no. 4, pp. 1143–1150, Jul./Aug. 2003.
- E. Babaei, M. F. Kangarlu, and M. Sabahi, “Mitigation of voltage disturbances using dynamic voltage restorer based on direct converters,” *IEEE Trans. Power Del.*, vol. 25, no. 4, pp. 2676–2683, Oct. 2010.
- B. Wang and G. Venkataramanan, “Dynamic voltage restorer utilizing a matrix converter and flywheel energy storage,” *IEEE Trans. Ind. Appl.*, vol. 45, no. 1, pp. 222–231, Jan./Feb. 2009.
- P. M. Garcia-Vite, F. M. David, and J.M. Ramirez, “Per-sequence vector-switching matrix converter modules for voltage regulation,” *IEEE Trans. Ind. Electron.*, vol. 60, no. 12, pp. 5411–5421, Dec. 2013.
- S. Subramanian and M. K. Mishra, “Interphase AC-AC topology for voltage sag supporter,” *IEEE Trans. Power Electron.*, vol. 25, no. 2, pp. 514–518, Feb. 2010.
- A. Prasai and D. M. Divan, “Zero-energy sag corrector with reduced device count,” *IEEE Trans. Power Electron.*, vol. 24, no. 6, pp. 1646–1653, Jun. 2009.
- J. Suma and M. K. Mishra, “Instantaneous symmetrical component theory based algorithm for characterization of three phase distorted and unbalanced voltage sags,” in *Proc. IEEE Int. Conf. Ind. Technol.*, Feb. 2013, pp. 845–850.
- A. Ghosh and G. Ledwich, *Power Quality Enhancement Using Custom Power Devices*. Norwell, MA, USA: Kluwer, 2002.
- M. Bollen, “Algorithms for characterizing measured three-phase unbalanced voltage dips,” *IEEE Trans. Power Del.*, vol. 18, no. 3, pp. 937–944, Jul. 2003.
- L. D. Zhang and M. H. J. Bollen, “Characteristic of voltage dips (sags) in power systems,” *IEEE Trans. Power Del.*, vol. 15, no. 2, pp. 827–832, Apr. 2000.
- IEEE Recommended Practice for Emergency and Standby Power Systems for Industrial and Commercial Applications, *IEEE Standard 446-1995*, Jul. 3, 1996.
- D.M. Vilathgamuwa, A. A. D. R. Perera, and S. S. Choi, “Voltage sag

compensation with energy optimized dynamic voltage restorer,” IEEE Trans. Power Del., vol. 18, no. 3, pp. 928–936, Jul. 2003.

- A. Camacho, M. Castilla, J. Miret, J. Vasquez, and E. A. Gallo, “Flexible

voltage support control for three phase distributed generation inverters under grid fault,” IEEE Trans. Ind. Electron., vol. 60, no. 4, pp. 1429–1440, Apr. 2013.

How to cite this article: Vimalraj M, Ahamed MR, Prasath RA. DVR based voltage sag compensation in multi-bus system with AC-AC converter topology. Int J Res Rev. 2015; 2(6):348-354.

International Journal of Research & Review (IJRR)

Publish your research work in this journal

The International Journal of Research & Review (IJRR) is a multidisciplinary indexed open access double-blind peer-reviewed international journal published by Galore Knowledge Publication Pvt. Ltd. This monthly journal is characterised by rapid publication of reviews, original research and case reports in all areas of research. The details of journal are available on its official website (www.gkpublication.in).

Submit your manuscript by email: gkpublication2014@gmail.com OR gkpublication2014@yahoo.com